

# QUICK START

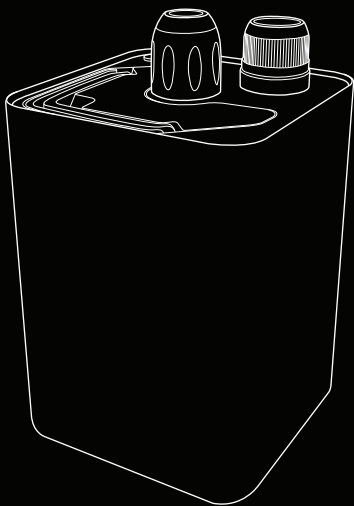

SteamOne

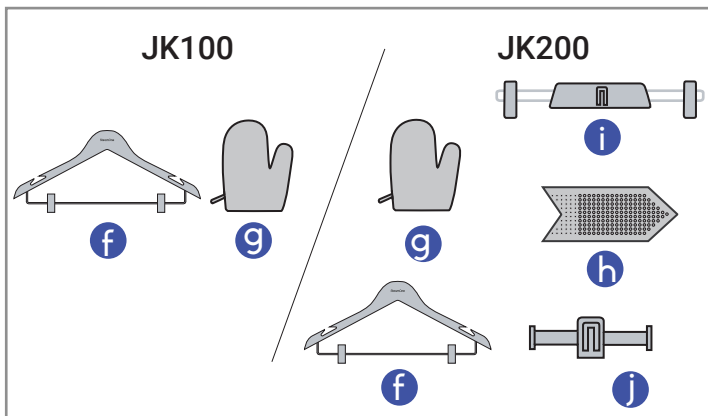
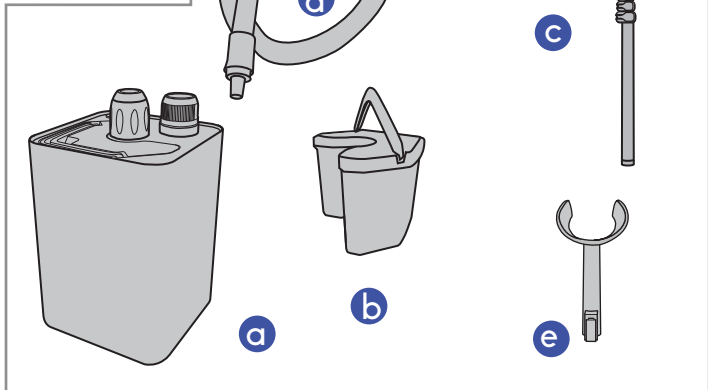

SteamOne

1

a + c

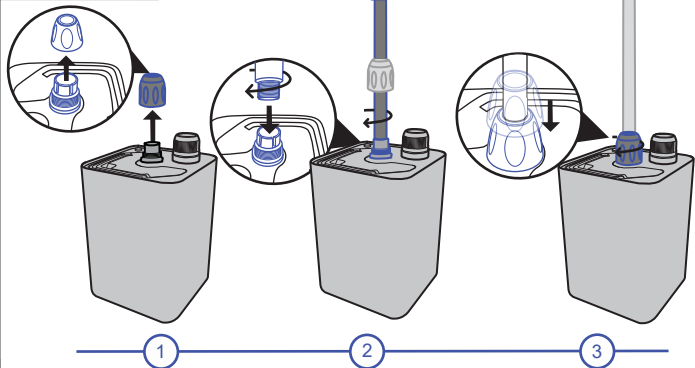

e →

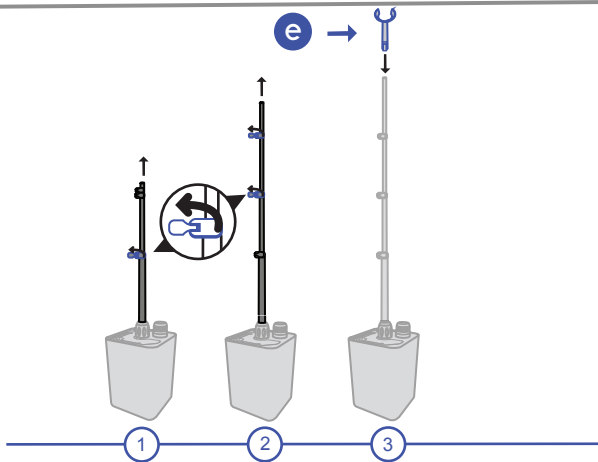

SteamOne

2

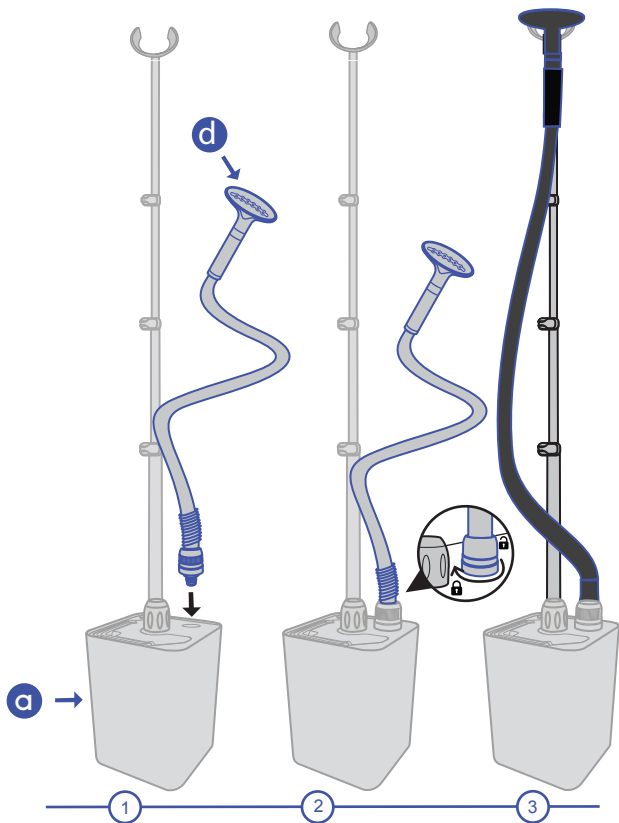

SteamOne

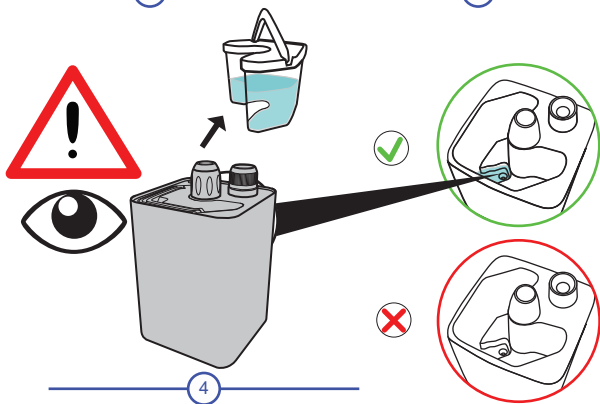
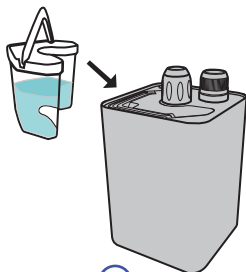
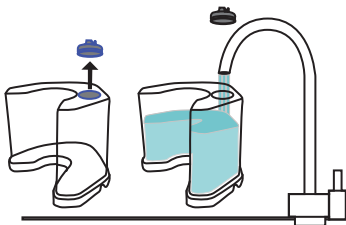
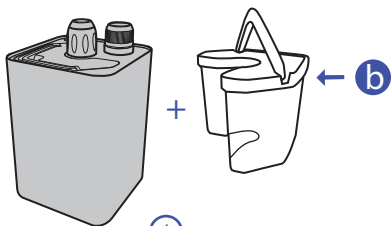

SteamOne

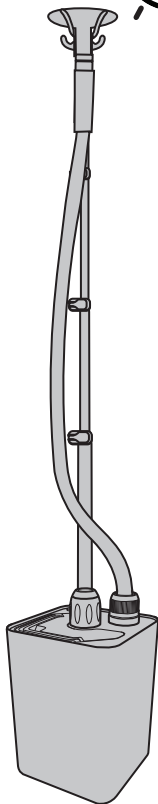

2

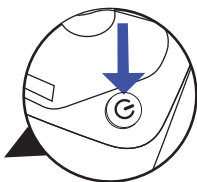

1

SteamOne



JK200 ONLY

e + f

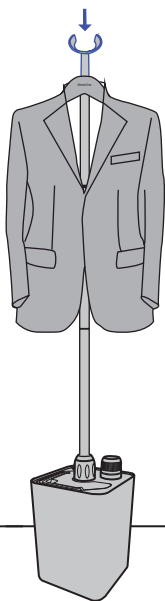

e + f

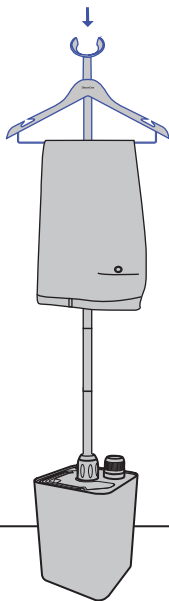

e + j

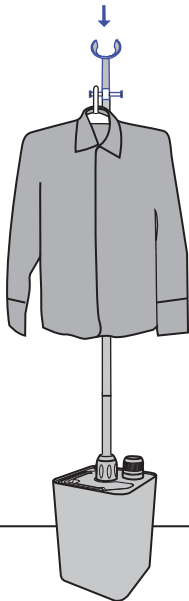

e + i

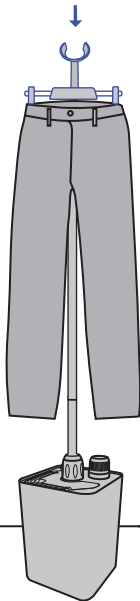

SteamOne



h

JK200 ONLY

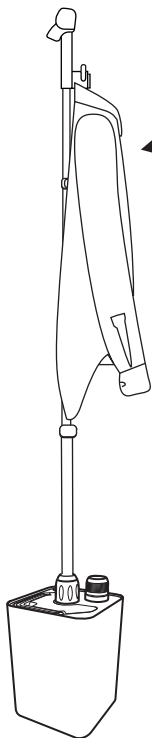
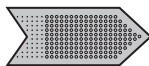

1

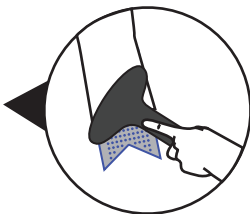

2

SteamOne



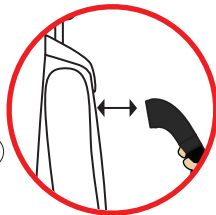

1



2

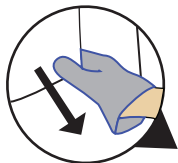

3

SteamOne

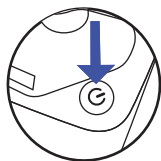

OFF

0

a →

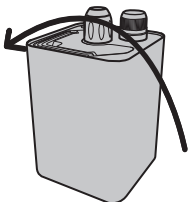

1

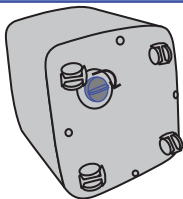

2

2

2

b →

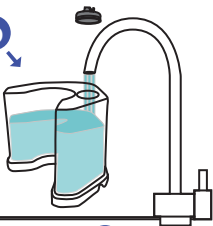

3

SteamOne

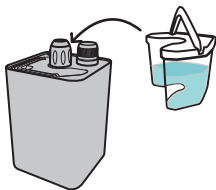

4

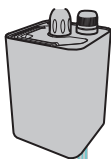

5

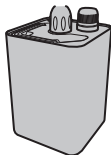

# SteamOne

EXPERT FRANÇAIS DU STYLE

---

[www.steam-one.com](http://www.steam-one.com)